

NACA...05 (S1) SERIES

STANDARD DAMPER ACTUATOR 2/3 POINT CONTROL



NACA...05 (S1) SERIES

NACA standard damper actuators are specially designed and produced for applications in the HVAC Systems. Our wide range of Nenutec standard damper actuators has been developed to operate and position air dampers of different sizes.

PRODUCT FEATURE

- Torque 5 Nm
- Damper size 1.0 m²
- Power supply AC/DC 24V or AC 230V
- Shaft dimensions - Ø 6...15 mm / □ 5...10 mm
- Minimum shaft length 40 mm
- Adjustable angle of rotation
- Selectable direction of rotation of reversing actuator
- Optional 1 fixed SPDT auxiliary switch
- Manual over-ride push button when required

MODEL SELECTION TABLE

MODEL / TYPE	TORQUE	POWER SUPPLY	RUNNING TIME	AUXILIARY SWITCH
NACA 1-05	5 Nm	AC/DC 24 V ± 10%	60...90 sec	-
NACA 1-05S1	5 Nm	AC/DC 24 V ± 10%	60...90 sec	1 x SPDT
NACA 2-05	5 Nm	AC 230 V ± 10%	60...90 sec	-
NACA 2-05S1	5 Nm	AC 230 V ± 10%	60...90 sec	1 x SPDT

DIMENSION (mm)

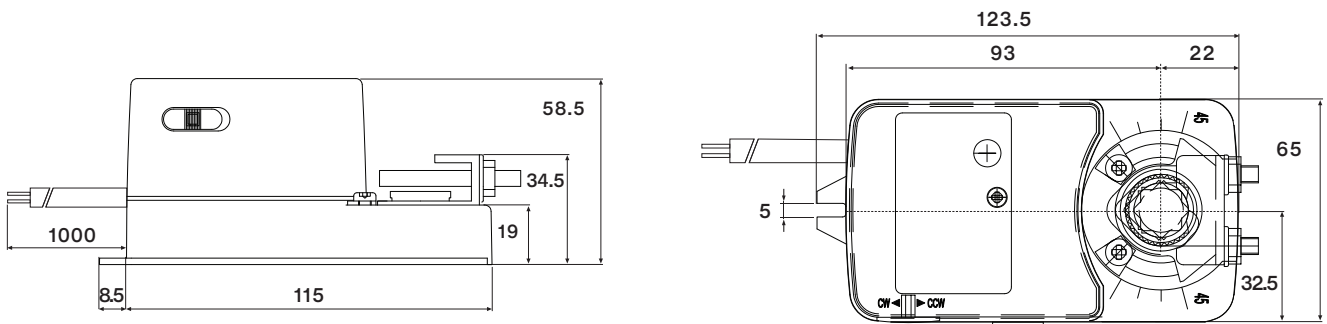

TECHNICAL SPECIFICATION

MODEL NUMBER	NACA 1-05 (S1)	NACA 2-05 (S1)
TORQUE	5 Nm	5 Nm
DAMPER SIZE	1.0 m ²	1.0 m ²
SHAFT DIMENSION	Ø 6...15 mm / □ 5...10 mm*	Ø 6...15 mm / □ 5...10 mm*
POWER SUPPLY	AC/DC 24 V ± 10%	AC 230 V ± 10%
FREQUENCY	50...60 Hz	50...60 Hz
CONTROL SIGNAL	2/3 point control	2/3 point control
POWER CONSUMPTION		
• OPERATING	2.0 W	2.0 W
• END POSITION	1.0 W	1.0 W
FOR WIRE SIZING	4.0 VA	4.0 VA
ELECTRICAL CONNECTION	1 m Cable	1 m Cable
AUXILIARY SWITCH RATING	3 (1.5) A, AC 250 V	3 (1.5) A, AC 250 V
PROTECTION CLASS	Class III ⚡	Class II ⚡
ANGLE OF ROTATION	90° (95° mechanical)	90° (95° mechanical)
WEIGHT	0.55 Kg	0.55 Kg
LIFE CYCLE	60,000 Rotation	60,000 Rotation
SOUND LEVEL	40 dB	40 dB
IP PROTECTION	IP54	IP54
OPERATING TEMPERATURE	-30°...50° as per IEC 721-3-3	-30°...50° as per IEC 721-3-3
NON-OPERATING TEMPERATURE	-30°...+60° C / IEC 721-3-2	-30°...+60° C / IEC 721-3-2
AMBIENT HUMIDITY	5%...95% rH non condensing / EN	5%...95% rH non condensing / EN
MAINTENANCE	Maintenance Free	Maintenance Free
MODE OF OPERATION	Type I / EN 60730-1	Type I / EN 60730-1
EMC	CE & ISO 9000 EN / EEC	CE & ISO 9000 EN / EEC

*Note that shaft dimension has a tolerance offset of ± 0.2mm.

NACA...05 (S1) SERIES

STANDARD DAMPER ACTUATOR 2/3 POINT CONTROL

WIRING DIAGRAM NACA...05 (S1) POWER SUPPLY AC/DC 24V OR AC 230V

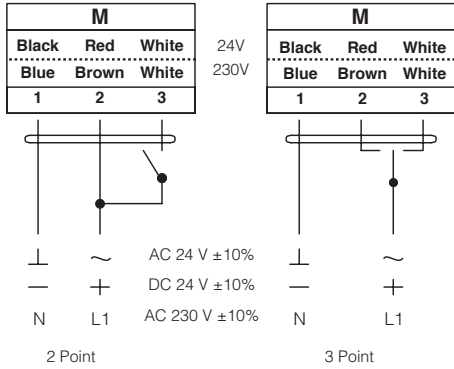

⚠ Connect via safety isolating transformer

DIRECTION OF ROTATION NACA...05 (S1)

Default factory setting: CW.

Direction of rotation can be changed by toggling between CW/CCW switch on the actuator's housing.

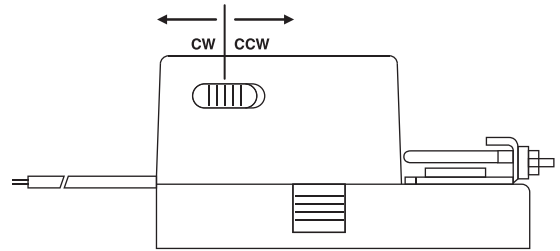

WIRING DIAGRAM NACA...05 (S1) AUXILIARY SWITCH

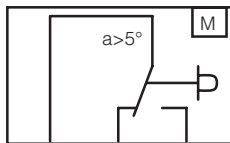

Orange S1 Yellow S2 Green S3

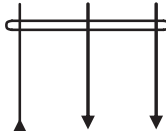

3 (1.5) A, AC 250 V
Actuator at 0° position

AUXILIARY SWITCH NACA...05 (S1)

Auxiliary switch (a) factory-set at 5°.

WIRING DIAGRAM NACA...05 (S1) PARALLEL CONNECTION

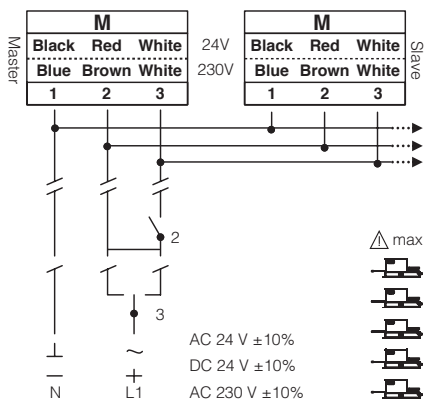

REMARK

Parallel connection of NACA...05 (S1) actuators are limited to 5. Power consumption must be observed.

LIMITING ANGLE OF ROTATION NACA...05 (S1)

Adjustment of Mechanical Limiter

1. Loosen screw of mechanical limiter
2. Move limiter to appropriate position*
3. Tighten screw

*Working range of 90° can be reduced up to 30° from end position.

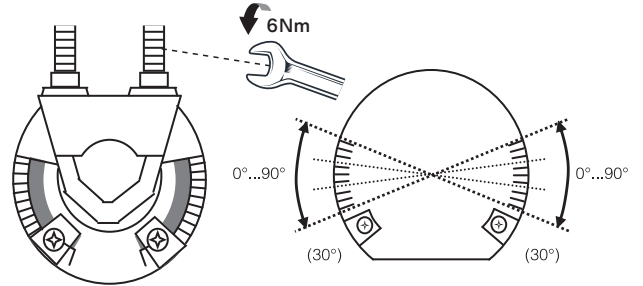

INSTALLATION / MOUNTING INSTRUCTION

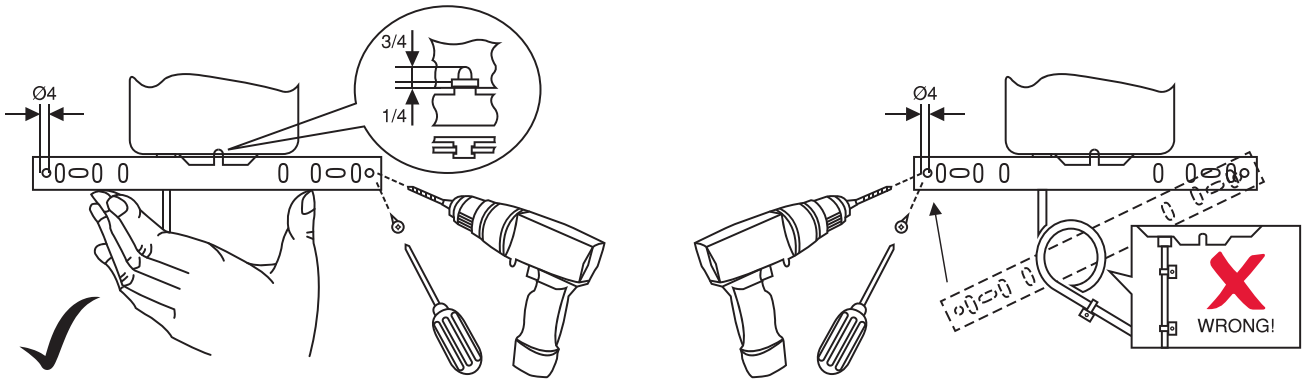

IMPORTANT REMARK

For special requirement, consult your local Nenutec's representative.



This actuator includes electrical and electronic components and may not be disposed as household garbage. Please consider the local valid legislation.



AC / DC 24 V:
AC 230 V:

Connect via safety isolating transformer.

To isolate from the main power supply, the system must incorporate a device which disconnects the phase conductor (with at least a 3mm contact gap.)

The performance specifications are nominal and conform to acceptable industry standards. NENUTEC shall not be liable for damages resulting from misapplication or misuse of its products.