

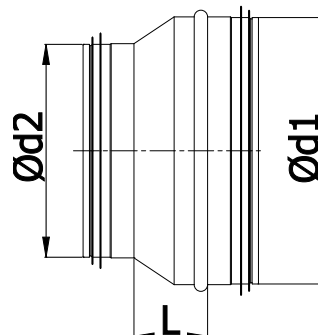

Dimensions



Description

RPCL – Pressed symmetric male-male reducer with EPDM gaskets.

$\varnothing d_1$ and $\varnothing d_2$ – fits SPR ducts.

Example identification

Product code: RPCL - aaa - bbb

type _____
 $\varnothing d_1$ _____
 $\varnothing d_2$ _____

$\varnothing d_1$ rated [mm]	$\varnothing d_2$ rated [mm]	L [mm]	weight [kg]
100	80	18	0,20
125	80	28	0,20
	100	22	0,20
140	100*	30	0,20
	125*	30	0,20
150	100	35	0,20
	125	30	0,20
160	80	48	0,30
	100	37	0,30
	125	26	0,20
180	125*	40	0,30
	140*	30	0,30
	150*	30	0,30
	160*	30	0,30
200	100	58	0,40
	125	46	0,40
	140	40	0,30
	150	35	0,30
	160	26	0,30
	180	30	0,30
224	150*	50	0,40
	160*	50	0,40
	180*	30	0,40
	200*	30	0,40
250	125	70	0,50
	150	60	0,50
	160	53	0,50
	180*	50	0,40
	200	31	0,60

Pressed male reducers

RPCL

[Download Wentyle](#)
[Download AlnorCAM](#)
[Buy via B2B](#)

Dimensions

$\varnothing d_1$ rated [mm]	$\varnothing d_2$ rated [mm]	L [mm]	weight [kg]
	224*	50	0,50
280	160*	80	0,60
	180*	70	0,60
	200*	60	0,60
300	224*	40	0,60
	200*	70	0,70
	224*	60	0,70
	250*	30	0,60
	280*	30	0,70
315	160	88	0,80
	180*	90	0,80
	200	68	0,70
	224*	60	0,70
	250	43	0,70
	280*	40	0,70
	300*	38	0,70
355	200*	110	1,10
	224*	90	1,00
	250*	70	1,00
	315*	30	0,90
400	200*	140	1,50
	224*	120	1,40
	250*	100	1,30
	315*	60	1,30
	355*	30	1,20
450	250*	140	2,00
	280*	110	1,90
	300*	100	1,90
	315*	90	1,80
	355*	60	1,70
	400*	40	1,70
500	250*	128	2,20
	300*	140	2,40
	315*	120	2,20
	355*	100	2,20
	400*	70	2,10
	450*	40	2,10
560	315*	170	2,90
	355*	140	2,80
	400*	110	2,70

$\varnothing d_1$ rated [mm]	$\varnothing d_2$ rated [mm]	L [mm]	weight [kg]
	450*	80	2,60
	500*	75	2,60
600	400*	130	3,10
	450*	100	3,00
	500*	70	2,70
	560*	30	2,40
630	315*	160	3,20
	400*	140	3,30
	450*	120	3,30
	500*	80	3,00
	560*	75	2,90
	600*	30	2,50

* Fabricated, the remaining entirely pressed.

Pressed reducers

RPCL/RPCFL/RPC/RPCF

Technical Data

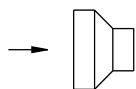

1 reduction stage

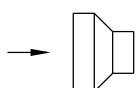
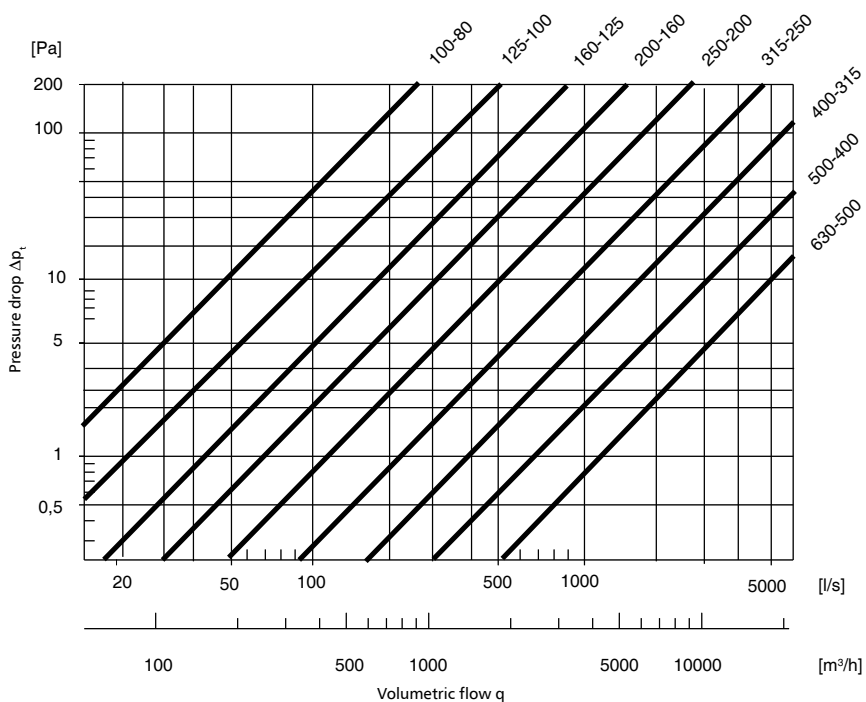

2 reduction stage

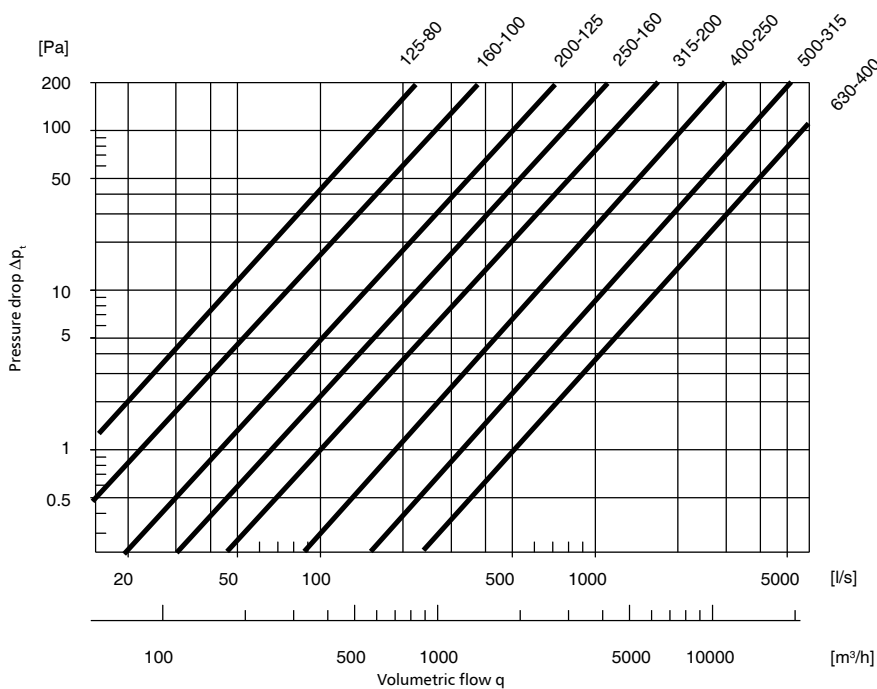

Pressed reducers

RPCL/RPCFL/RPC/RPCF/RPCN/RPCNR

[Download Wentyle](#)
[Download AlnorCAM](#)
[Buy via B2B](#)

Technical Data

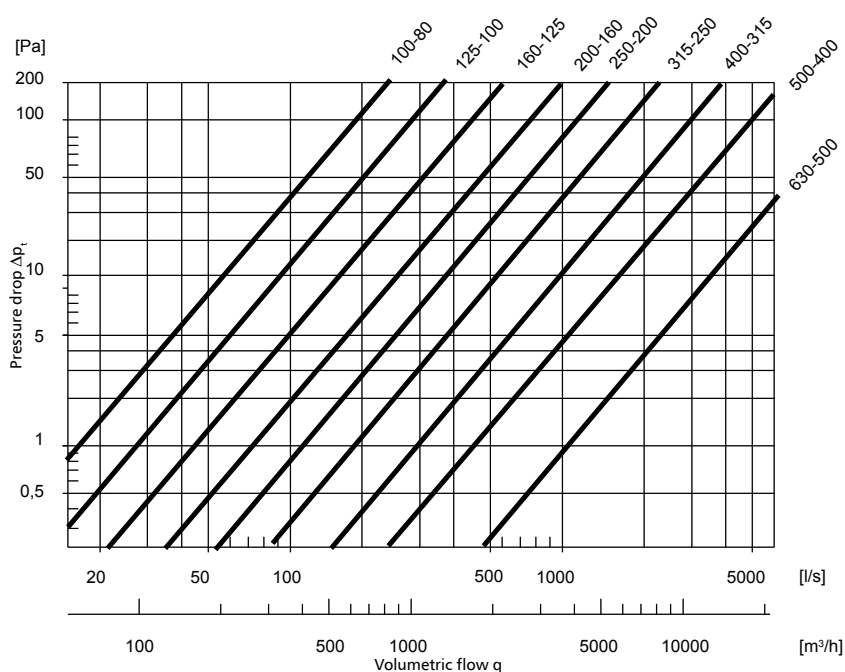
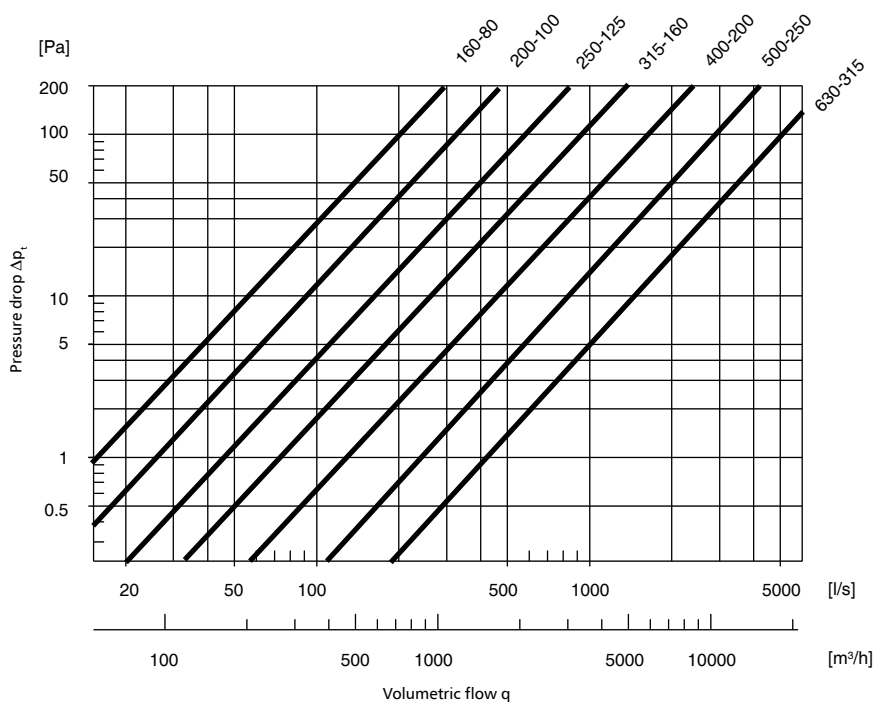
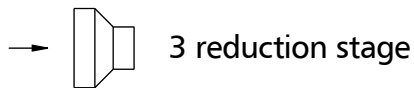

Technical Data

